

# MOX-LAN-QP4B-1100



## SURFACE MOUNT 10/100 BASE-T QUAD PORT TRANSFORMERS

MoxiE's LAN-QP4B-1100 series of surface mount quad port transformers are designed with a compact footprint and a low profile.

### FEATURES:

- MoxiE UL certified for United States and Canada.
- Symmetrical TX and RX channels for auto MDI/MDIX compatibility.
- Approved for use with Broadcom BCM5226 and Level One LXT9784.
- Meets IEEE 802.3 & ANSI X3.263 standards.
- 350µH OCL with 8mA bias.
- RoHS compliant.
- Sealed bottom case design.
- MoxiE Inductor Corporation custom designs available.

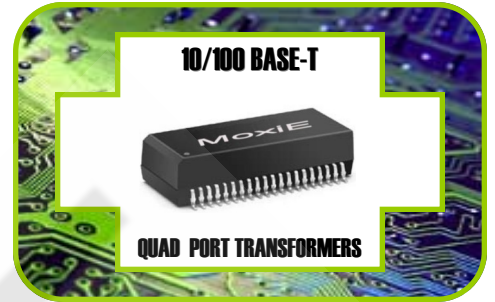

## QP4B-1111 DIMENSIONS

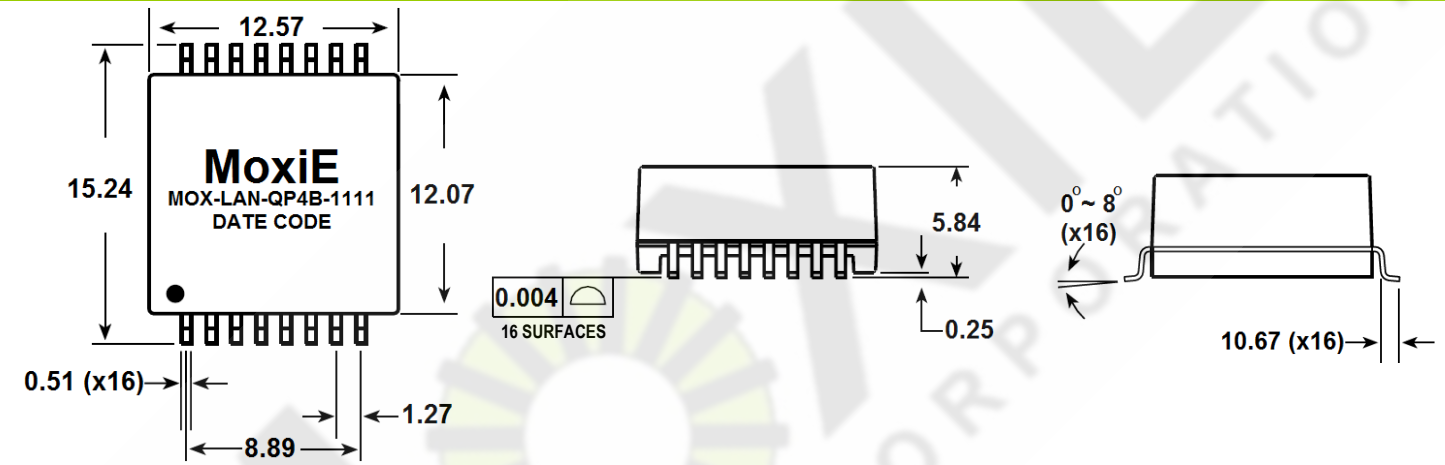

## QP4B-1134 / 1140 / 1142 / 1164 DIMENSIONS

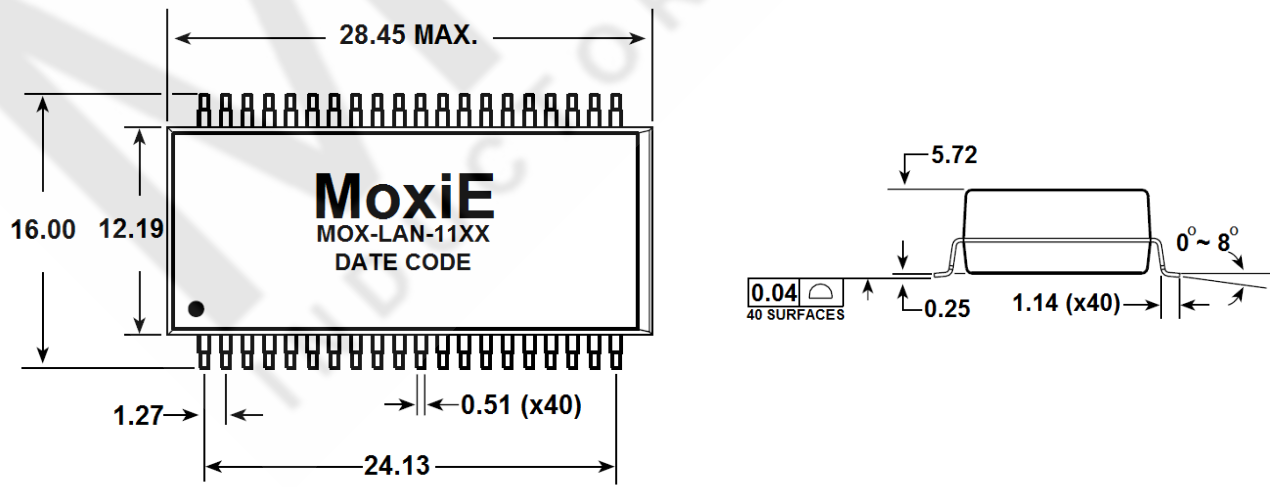



## LANDING PATTERNS

1134 / 1140 / 1142 / 1164 SERIES

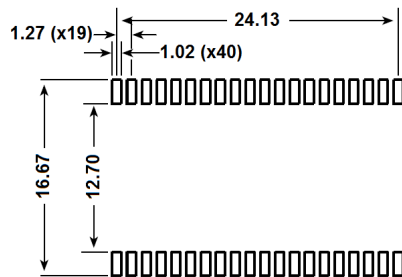

1111 SERIES

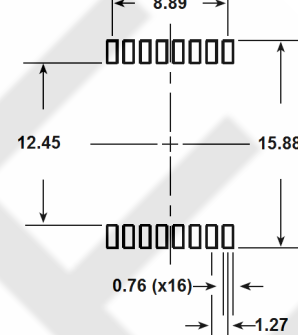

## ELECTRICAL SPECIFICATIONS

MoxiE Part Number	Insertion Loss		Return Loss (dB Typ)				Crosstalk (dB Typ)				Differential to Common Mode Rejection (dB TYP.)		HiPot
	0.1 ~ 100 MHz	2~30 MHz	40 MHz	50 MHz	60~80 MHz	1 KHz	30 MHz	60 MHz	100 MHz	1~60 MHz	60~200 MHz	(Vrms)	
MOX-LAN-QP4B-1140	-1.0	-18	-14.4	-13.1	-12	-65	-50	-40	-35	-40	-35	1500	
MOX-LAN-QP4B-1111	-1.0	-18	-14.4	-13.1	-12	-65	-50	-40	-35	-40	-35	1500	
MOX-LAN-QP4B-1164	-1.0	-18	-14.4	-13.1	-12	-55	-45	-40	-33	-37	-25	1500	
MOX-LAN-QP4B-1134	-1.4	-18	-14.4	-13.1	-12	-55	-45	-40	-33	-37	-25	1500	
MOX-LAN-QP4B-1142	-1.0	-16.5	-16	-15.5	-12	-60	-43	-38	-33	-43	-27	1500	



## NOTES

### MoxiE Notes:

- Operating temperature  $-20^{\circ}\text{C}$  to  $+70^{\circ}\text{C}$ .
- MSL = Moisture Sensitivity Level a=1 b=2 c=3 d=4
- Meets RoHS-6 peak reflow rating of  $245^{\circ}\text{C}$ .
- RoHS-6 Compliant: MoxiE Product does not contain 5 out of the 6 banned substances specified in the RoHS directive.
- Some internal connections may contain lead in high-temperature solder (solder alloys containing more than 85% lead).
- Packaging: Tube (45 pcs) or tape & reel (600 pcs)
- MoxiE Inductor Corporation specifications are subject to change without notice.
- MoxiE Inductor Corporation LAN-QP4B transformers are UL certified.



## SCHEMATICS

### MOX-LAN-QP4B-1140 & 1142

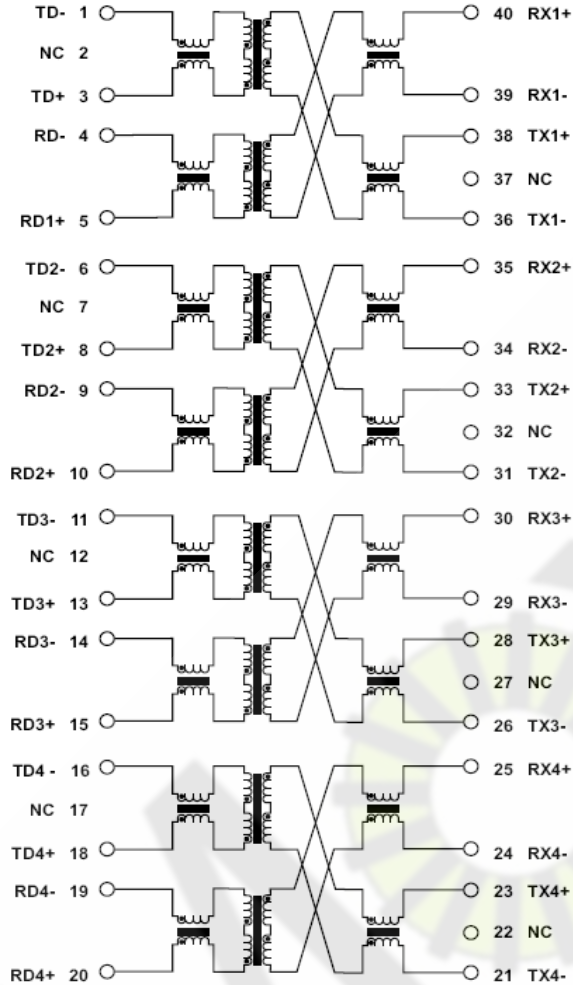

### MOX-LAN-QP4B-1111

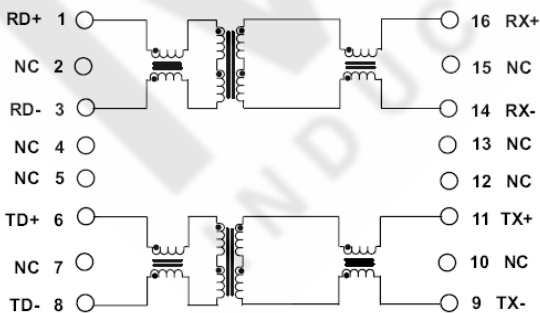

### MOX-LAN-QP4B-1164 & 1134

